

MERCURY TQB & TRB THERMAL BREAK FRAME INSTALLATION MASONRY, METAL STUD, and WOOD STUD WALLS

JOBSITE STORAGE: Store frames off the ground on at least 4" high wood runners or skids, in a manner that will prevent rust or damage. Do not store directly on the ground. Assembled frames shall be stored vertically. Cover frames with tarpaulin or plastic but do insure that adequate ventilation is provided to eliminate moisture condensation.

*It has been found that grouting allows an excess of thermal bridging from one side of the frame to the other. Therefore, it is not recommended in a thermal break frame.

ASSEMBLY of KD (Knock Down) THERMAL BREAK FRAME

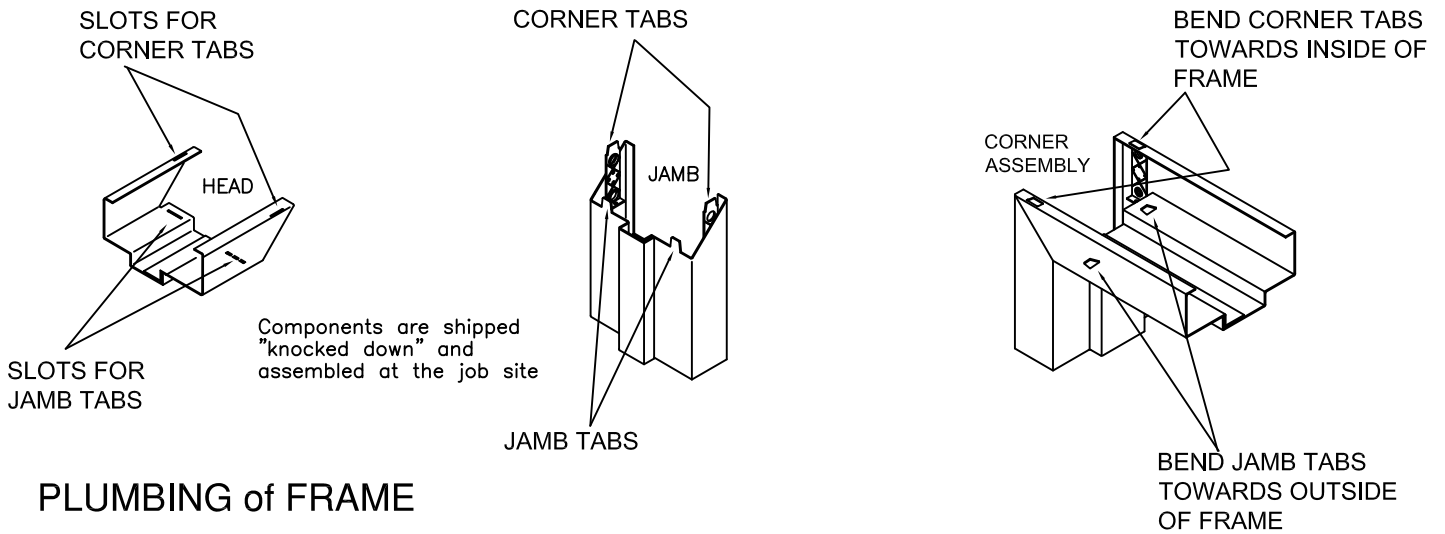

PLUMBING of FRAME

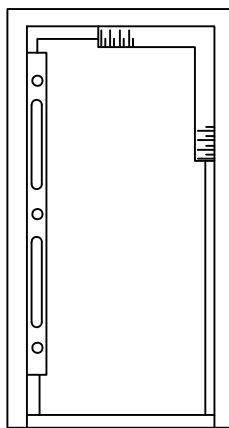

The installer should use wood spreaders (as described at right), a carpenters level (the longer the better), and a carpenters square (the bigger the better). Set the frame in the desired location. Level head and plumb jamb. Shim under jamb if necessary.

Typical wood spreaders must be square and made from lumber at least 1" thick. Length of spreader equals door opening width at the head. Cut clearance notches for frame stops as shown. Spreader must be nearly as wide as frame depth for proper installation.

ASSA ABLOY

MASONRY WALL CONSTRUCTION

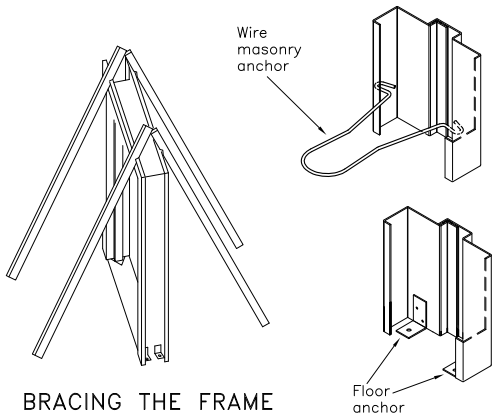

BRACING THE FRAME

NOTE: If frame is received setup and welded, remove and discard the temporary metal supports that are tack welded to jambs at sill before starting installation.

Brace the frame as shown or shore to ceiling. Do not brace in the direction of intended wall. Plumb and square jambs. Set spreader. Attach jambs to floor through floor anchor.

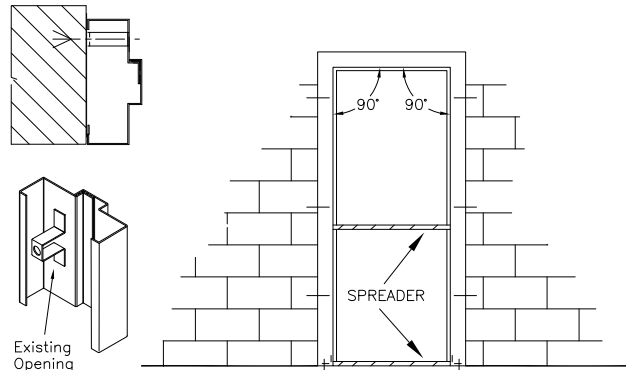

INSTALLING THE FRAME

Set and plumb frame. Install jamb anchors at hinge levels as wall is laid up. (3 WMA anchors for heights to 7'-2" – one more anchor per jamb for each additional 2 feet of height or fraction thereof.) A second spreader should be used at mid-point of opening to maintain the door opening dimension. continually check plumb and square as wall progresses. CHECK: The difference between diagonals measured from opposite corners should not exceed 1/16".

WOOD or METAL STUD WALL CONSTRUCTION

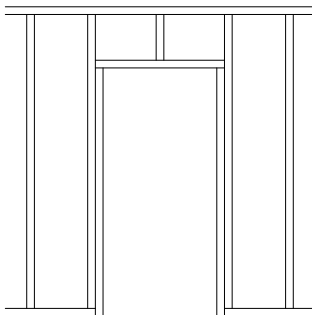

ROUGH STUD OPENING

ADD 3/8" TO OVERALL FRAME WIDTH
ADD 1/8" TO OVERALL FRAME HEIGHT

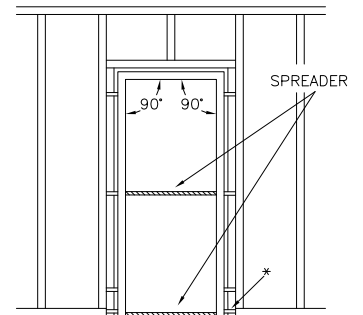
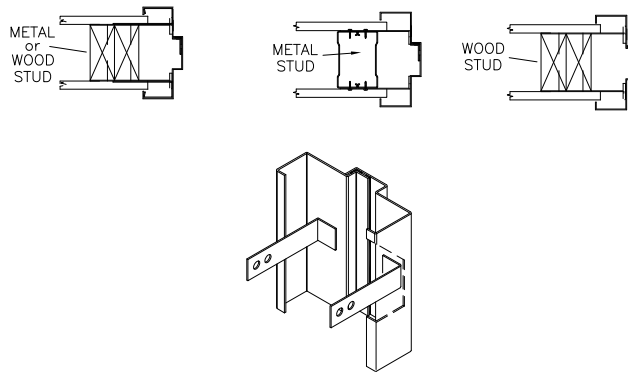

INSTALLING THE FRAME

1. Build the rough opening in wall allowing 3/16" clearance between upright stud and frame jamb and 1/8" clearance between header and top of door frame. *

2. Insert jamb anchors in frame throat and tap into place with a hammer if snap-in loose anchors are provided.

3. Place frame in rough opening.

4. Set spreaders and level frame. Shim jambs if necessary.

*If you choose to erect door frame before wall framing: brace frame and anchor at sill per masonry procedure above, then fit studs inside the throat of the frame, wrapping the stud by at least 5/8".

5. Square and fasten top anchors to stud on ONE JAMB ONLY. Check plumb and square of door frame and continue to fasten balance of anchors to studs. Repeat on opposite jamb.

6. Fasten supplied anchor straps to stud with suitable wood screws, nails, or sheet metal screws. Use (4) fasteners per anchor (min.), two per strap.

7. Maintain necessary clearance between frame returns and stud for inserting wall board. Do not install wall board until you are sure that frame is plumb and square.

8. Pemko S44 compression type gasket is shipped loose with frame. Gasket is to be applied after finish paint.