

**SERIES/PROFILE**

**DCB**

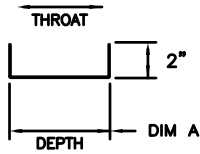

- 18 GA
- 16 GA
- 14 GA

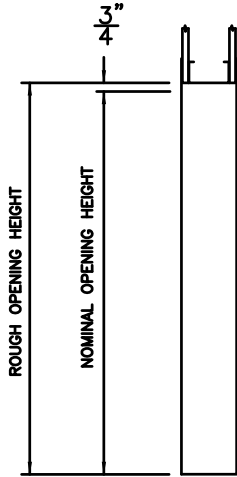

**VERTICAL SECTION**

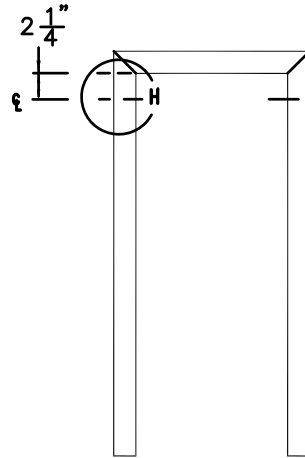

**SINGLE OPENING ELEVATION**

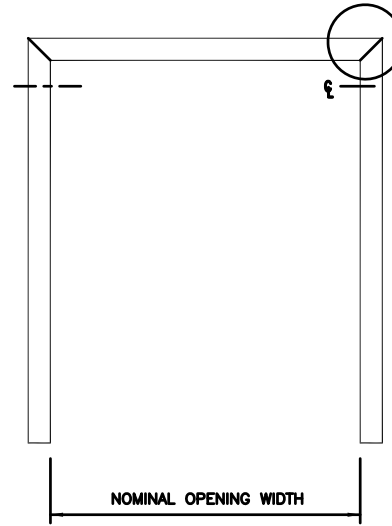

**DOUBLE OPENING ELEVATION**

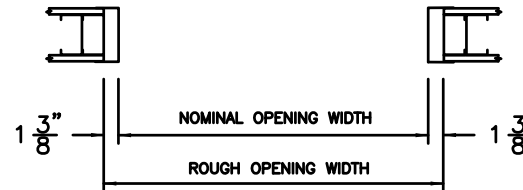

**HORIZONTAL SECTION**

**F**

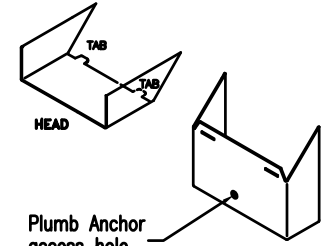

**KNOCKED DOWN**

Plumb Anchor access hole with screw.

**H**

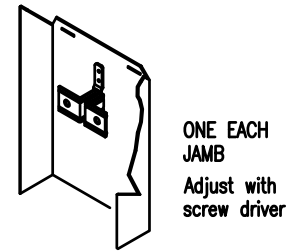

**ADJUSTABLE PLUMB ANCHOR**

ONE EACH JAMB  
Adjust with screw driver

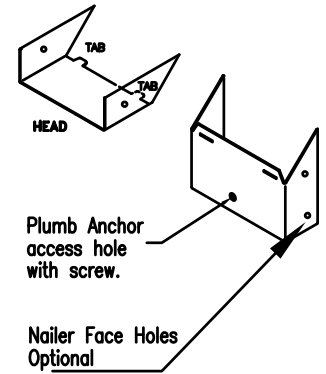

Plumb Anchor access hole with screw.

Nailer Face Holes Optional

**Series DCB Depths**

DIM A	3" THRU 14"
-------	-------------

C.R. steel is standard.  
Galvanized steel is optional.

**CecoDoor** (Conversion: 1" = 25.4 mm, e.g., 1-3/4" = 44.45 mm)

**ASSA ABLOY**

DRAWN BY _____	DATE _____			
CHK'D BY _____	DATE _____			
SHT _____ OF _____	CONTRACT NO. _____	ISSUE DATE _____	REVISIONS _____	BY _____

**SERIES DCB CASED OPENING FRAMES**  
(SLIP-ON DRYWALL FRAMES)

FURNISHED WITH ONE COAT OF NUETRAL COLOR PRIMER PAINT.  
PRIME PAINT HAS BEEN TESTED IN CONFORMANCE WITH ANSI A250.10.