

DOOR DESIGNS

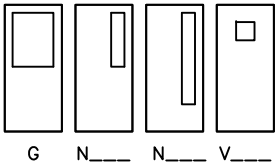

TYPE 2 APPLIED LIGHT KIT IS FACTORY INSTALLED WITH NON-FIRE RATED SG5™ GLASS, TREMCO 440 GLAZING TAPE & DOW CORNING 995 SILICONE GLAZING COMPOUND.

- 18 GA. (.043") MIN. TYPE 2 VISION LIGHT KIT

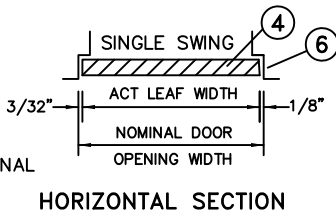
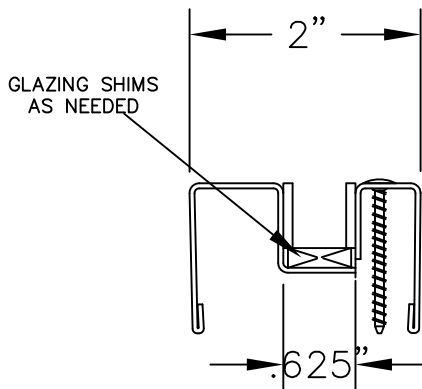
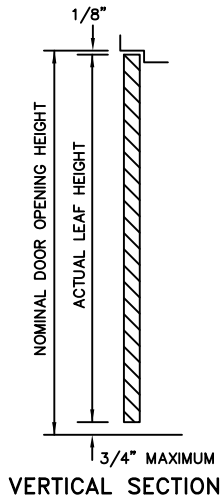
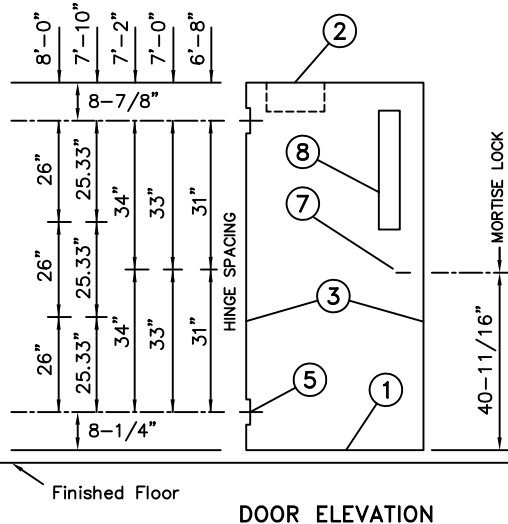
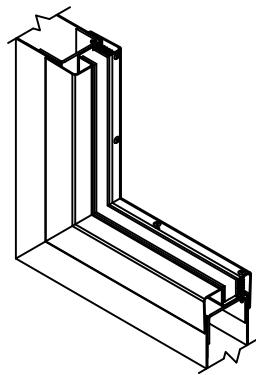

1 END CHANNELS

INVERTED TOP AND BOTTOM
18 GAGE FLUSH TOP & BOTTOM CAPS OPTIONAL

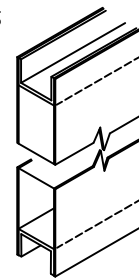

2 CLOSER REINFORCEMENT (OPTIONAL)

14 GAGE STEEL CHANNEL 20"

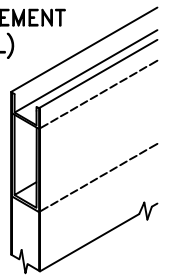

3 VERTICAL EDGES

MECHANICALLY INTERLOCKED HEMMED EDGES
ALSO AVAILABLE SEAMLESS (WELDED OR BODY FILLER)

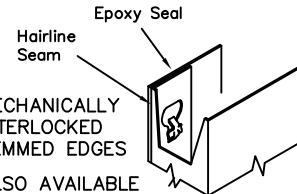

4 CORE

FOAMED-IN PLACE POLYURETHANE CORE
CHEMICALLY BONDED TO ALL INTERIOR SURFACES

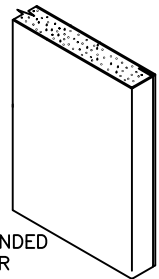

5 HINGE PREPARATION

4-1/2 OR 5 IN. HIGH, STANDARD OR HEAVY WEIGHT, FULL MORTISE HINGES
ANSI A156.7 TEMPLATE
HANDED

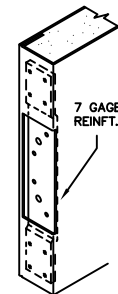

6 LOCK EDGE

BEVEL 1/8" IN 2"

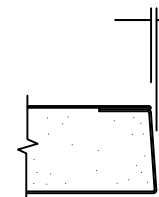

SARGENT MORTISE LOCK PREPARATIONS
8224, 8225, 8226, 8227, 8235, 8239, 8240, 8241, 8243, 8245, 8246, 8247, 8248, 8249, 8250, 8251, 8252, 8266, 8268

***CORBIN RUSSWIN MORTISE LOCK PREPARATIONS**
ML2020, ML2022, ML2024, ML2029, ML2030, ML2048, ML2065, ML2067, ML2072, ML2073, ML2075, ML2082, ML2092

***YALE MORTISE LOCK PREPARATIONS**
SL8802, SL8811, SL8812, SL8817, SL8818, SL8822, SL8823, SL8827, SL8830, SL8831, SL8832, SL8840, SL8847, SL8860, SL8861

LOCK PREPARATION GOV. 86, ANSI/BHMA A115.1 MORTISE TYPE (LM2)

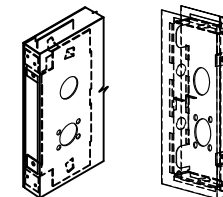

NOTE: EITHER OF THE LOCK REINFORCEMENTS/GUARDS SHOWN MAY BE INSTALLED WITH 8200 SERIES MORTISE LOCK WITH LATCH BOLT, DEAD BOLT & LS ESCUTCHEON

FIRE DOORS

N/A IN THIS DESIGN & CONSTRUCTION

COLD ROLLED STEEL IS STANDARD

GALVANNEALED AND GALVANIZED STEEL ARE OPTIONAL

1-3/4" IMPERIAL (IU) 16 GAUGE ATTACK RESISTANT DOOR

(Conversion: 1" = 25.4 mm, e.g., 1-3/4" = 44.45 mm)

*EQUIVALENT HARDWARE NOT TESTED



ASSA ABLOY

DRAWN BY _____ DATE _____
CHK'D BY _____ DATE _____

SHT _____ CONTRACT NO. _____
OF _____

ISSUE DATE _____ REVISIONS _____ BY _____

FOR HAND & SWING
SEE DOOR SCHEDULE



THERMAL INSULATION VALUE _____
SCHOOL GUARD GLASS _____
ATTACK RESISTANT TEST DATA _____

CORE CALCULATED (ASTM C518) R = 11.01 U = 0.091
SG5™ COMPLIES WITH UL 972, ASTM C1036, C1172 & ANSI Z97.1
PASSED 3RD PARTY TESTING AT H.P. WHITE LABORATORY INC. TESTED TO 5a10 CERTIFICATION STANDARDS FOR REINFORCING AND TESTING OF STANDARD WOOD AND METAL DOORS, FRAMES, GLASS & HARDWARE FOR (4) MINUTE ATTACK.