

**DOOR DESIGNS**

**SECURITY GLAZING KITS**

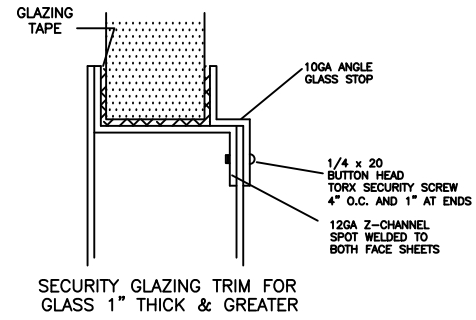
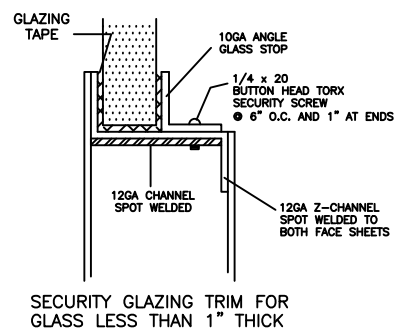
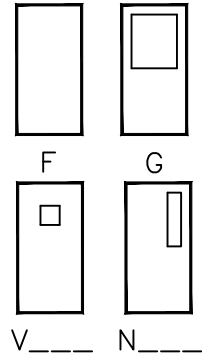

SECURITY GLAZING TRIM FOR GLASS LESS THAN 1" THICK

SECURITY GLAZING TRIM FOR GLASS 1" THICK & GREATER

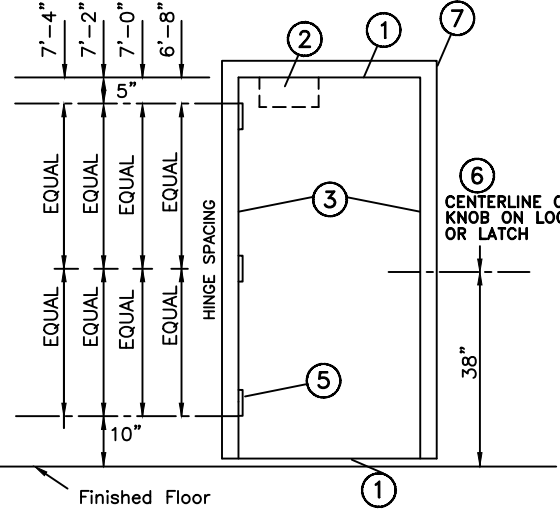

DOOR ELEVATION

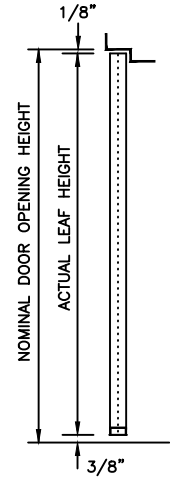

VERTICAL SECTION

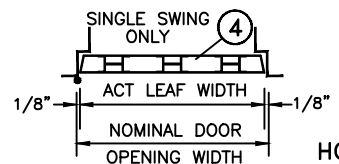

HORIZONTAL SECTION

**FIRE DOORS**

TESTS: UL10B, UL10C, NFPA252 & UL1784

LABELING AGENCY: UL LLC

RATING: 20 MIN. THRU 90 MINS. (SINGLE)

MAXIMUM SIZE: 3'6" x 7'4" (SINGLE)(UL)

Cold rolled steel is standard  
Galvanized or galvanealed steel is optional

- GRADE 4
- GRADE 3

**1 10 GAGE STEEL END CHANNELS**

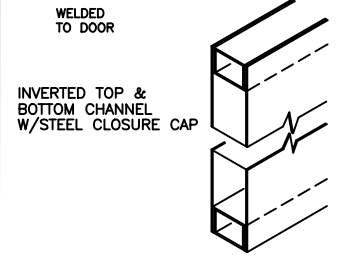

**2 CLOSER REINFORCEMENT (OPTIONAL)**

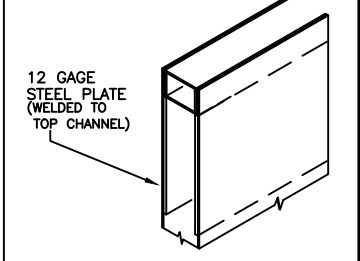

**3 VERTICAL EDGES**

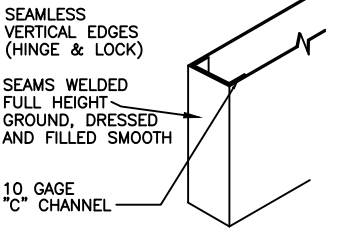

**4 CORE**

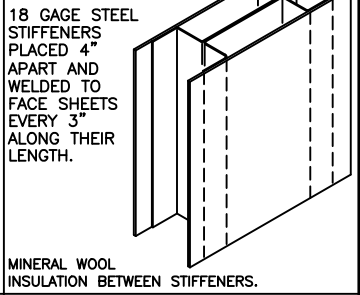

EXTRA HEAVY PERIMETER REINFORCEMENT

MINERAL WOOL INSULATION BETWEEN STIFFENERS.

**5 HINGE PREPARATION**

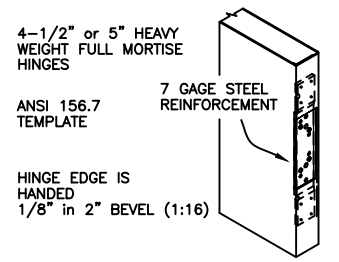

**6 LOCK PREPARATION**

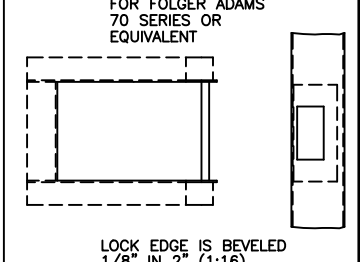

**7 TYPICAL PROFILE**

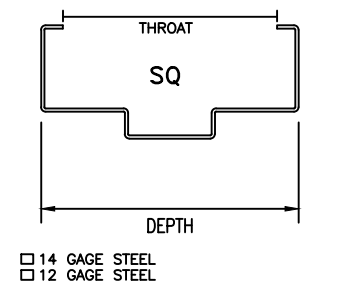

**7 FRAME CORNER CONSTRUCTION**

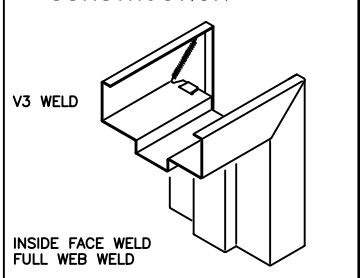

**2" RESTRICTDOR DETENTION SECURITY DOOR SYSTEM**

14 GAGE FULL FLUSH DOORS/14 OR 12 GAGE FRAMES  
VERTICALLY STEEL-STIFFENED, DOUBLE BEVEL, HANDED

**CecoDoor** (Conversion: 1" = 25.4 mm, e.g., 1-3/4" = 44.45 mm)

**ASSA ABLOY**

DRAWN BY _____ DATE _____		FOR HAND & SWING SEE DOOR SCHEDULE	
CHK'D BY _____ DATE _____		<b>Welded Anchors</b> Yoke & Strap Masonry Jamb Anchors, One-Piece Floor Anchor	
SHT _____ OF _____	CONTRACT NO. _____		
ISSUE DATE _____	REVISIONS _____	BY _____	

The RestrictDor Detention Security Door and Frame System complies with ANSI/NAAMM, HMMA 863-98, Guide Specifications for Detention Security Hollow Metal Doors & Frames (Grade 4 OR Grade 3)

Experience a safer and more open world