

**PROFILES**

DOUBLE RABBET

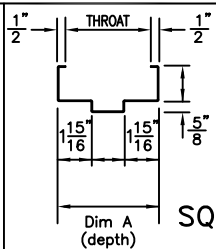

**LOCK STRIKE PREPARATION**

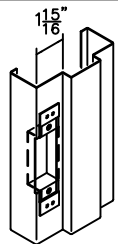

**UNIVERSAL (4-7/8")**  
ANSI A115.1 & 2 TEMPLATE  
16 GAGE STEEL REINFORCING  
WITH EXTRUDED THREADS EQUAL  
TO 14 GAGE (STANDARD)

**CYLINDRICAL (2-3/4")**  
(Not shown)  
ANSI A115.3 TEMPLATE  
16 GAGE STEEL REINFORCING  
WITH EXTRUDED THREADS EQUAL  
TO 14 GAGE (OPTIONAL)

SGL RABBET

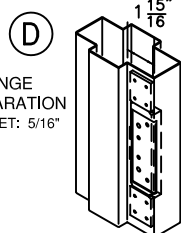
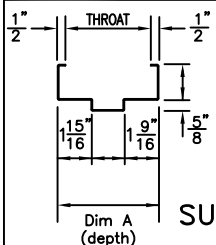

**HINGE PREPARATION**  
BACKSET: 5/16"

4-1/2 OR 5 IN.  
HIGH, HEAVY WEIGHT  
FULL MORTISE  
HINGES  
DOORS OVER 3'0"x7'0"  
REQUIRE 5" x .190  
HINGES.

ANSI A156.7  
TEMPLATE  
(CONTINUOUS HINGE  
OPTIONAL)

12 ga. C.R.S. steel is standard.  
12 ga. Galvanized steel is optional.

**ARMORSHIELD DEPTHS**

Profile	Dim A
Double Rabbet:	5-1/4" - 13-7/8"
Single Rabbet:	4-5/8" - 5-1/8"

The ArmorShield system is rated for super power small arms (level 3) and is intended for architectural environments with equivalent bullet resistance. The system has not been tested for resistance to forced entry. Field assembly of welded frame and door is required as is preparation for surface applied hardware. System shall be installed securely by contractor in a manner to achieve the intended functional operation and appearance. The door and frame must be finish color painted after delivery to site.

**CecoDoor** (Conversion: 1" = 25.4 mm, e.g., 1-3/4" = 44.45 mm)

**ASSA ABLOY**

DRAWN BY \_\_\_\_\_ DATE \_\_\_\_\_  
CHK'D BY \_\_\_\_\_ DATE \_\_\_\_\_

SHT \_\_\_\_\_ CONTRACT NO. \_\_\_\_\_  
OF \_\_\_\_\_

ISSUE DATE \_\_\_\_\_ REVISIONS \_\_\_\_\_ BY \_\_\_\_\_

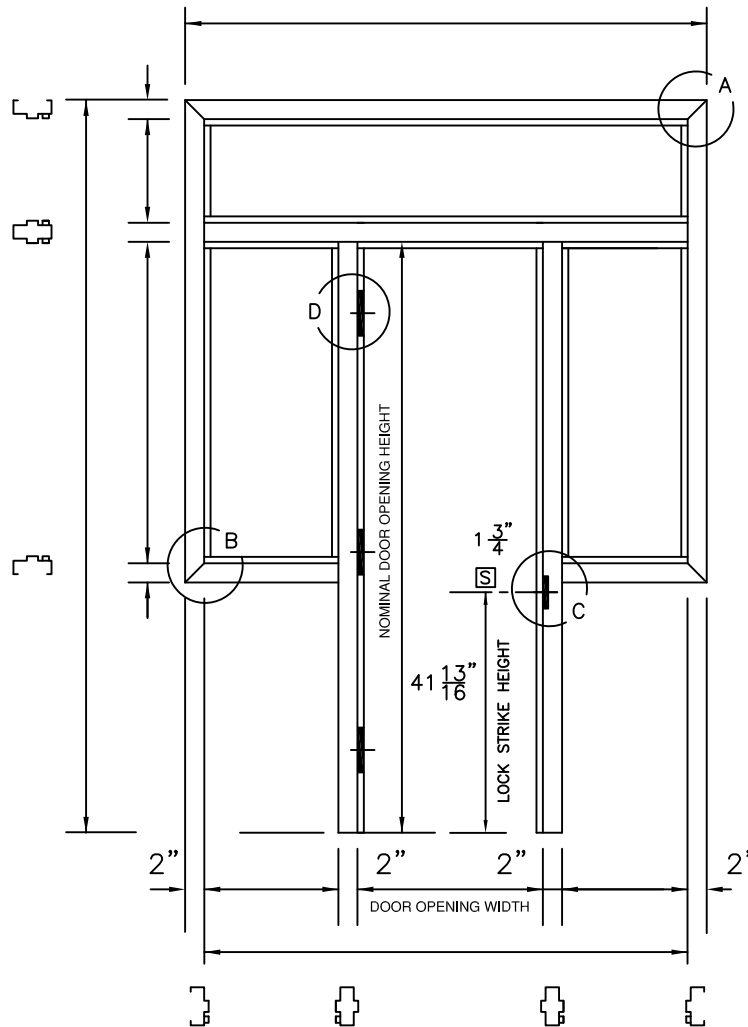

ELEVATION \_\_\_\_\_

MARK \_\_\_\_\_

For construction illustrations see page(s): \_\_\_\_\_

RATING ▶	MEDIUM POWER LEVEL 1	HIGH POWER LEVEL 2	SUPER POWER LEVEL 3
SMALL ARMS	SUPER 38 AUTOMATIC	.357 MAGNUM REVOLVER	.44 MAGNUM REVOLVER
BARREL LENGTH	5"	8 1/4"	6 1/2"
BULLET TYPE	METAL CASE 130 GRAIN	SOFT POINT 158 GRAIN	SOFT POINT 240 GRAIN
MUZZEL VELOCITY	1280 FPS	1450 FPS	1470 FPS
MUZZEL ENERGY	475 FT-LB	740 FT-LB	1150 FT-LB

**WELDED CORNERS**

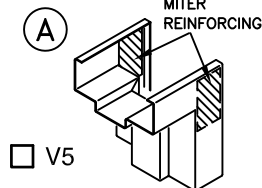

□ V5

MITERED AND WELDED CORNER -- HEAD AND JAMB FACES MUST BE EQUAL

GLASS -- UL LISTED

UL LISTED, SPSA RATED  
MIN. SIZE: 12" x 12"  
GLASS THICKNESS VARIES

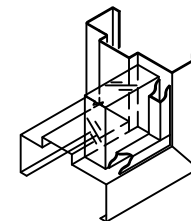

ALL INTERSECTIONS ARE FACE WELDED AND GROUND SMOOTH.

**LEVEL 1, 2, & 3 ARMORSHIELD  
UL LISTED BULLET RESISTANT  
TF2PSL SYSTEM**

TESTED IN ACCORDANCE WITH BULLET RESISTANT EQUIPMENT TEST: UL 752

FOR HAND & SWING  
SEE DOOR SCHEDULE



FOR ANCHORAGE  
SEE DOOR SCHEDULE &  
ANCHOR SHEET

